

GREAT LAKES DETAIL SHEET - 10-28-21 - REVISION 02

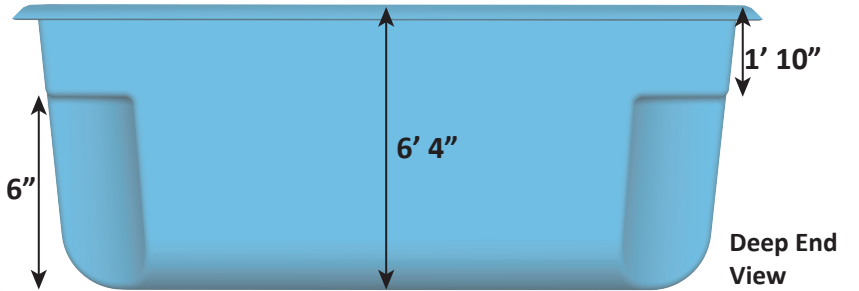

USA Specifications

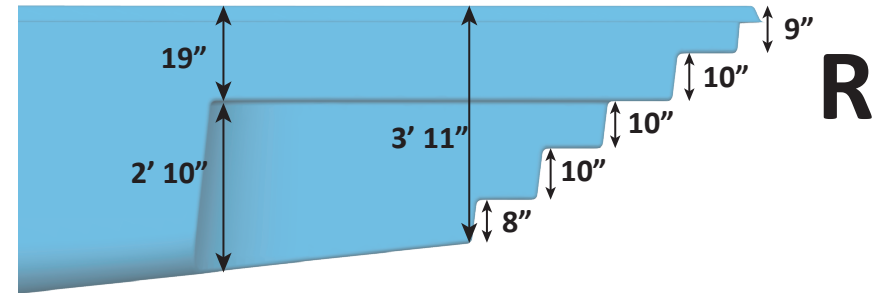
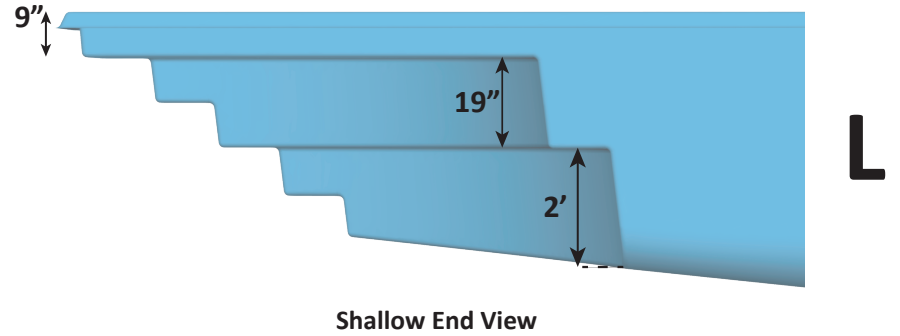
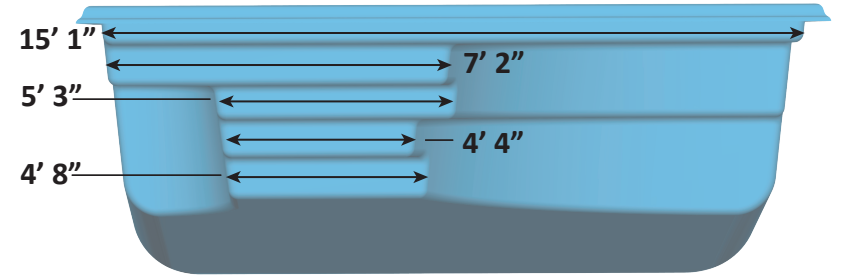
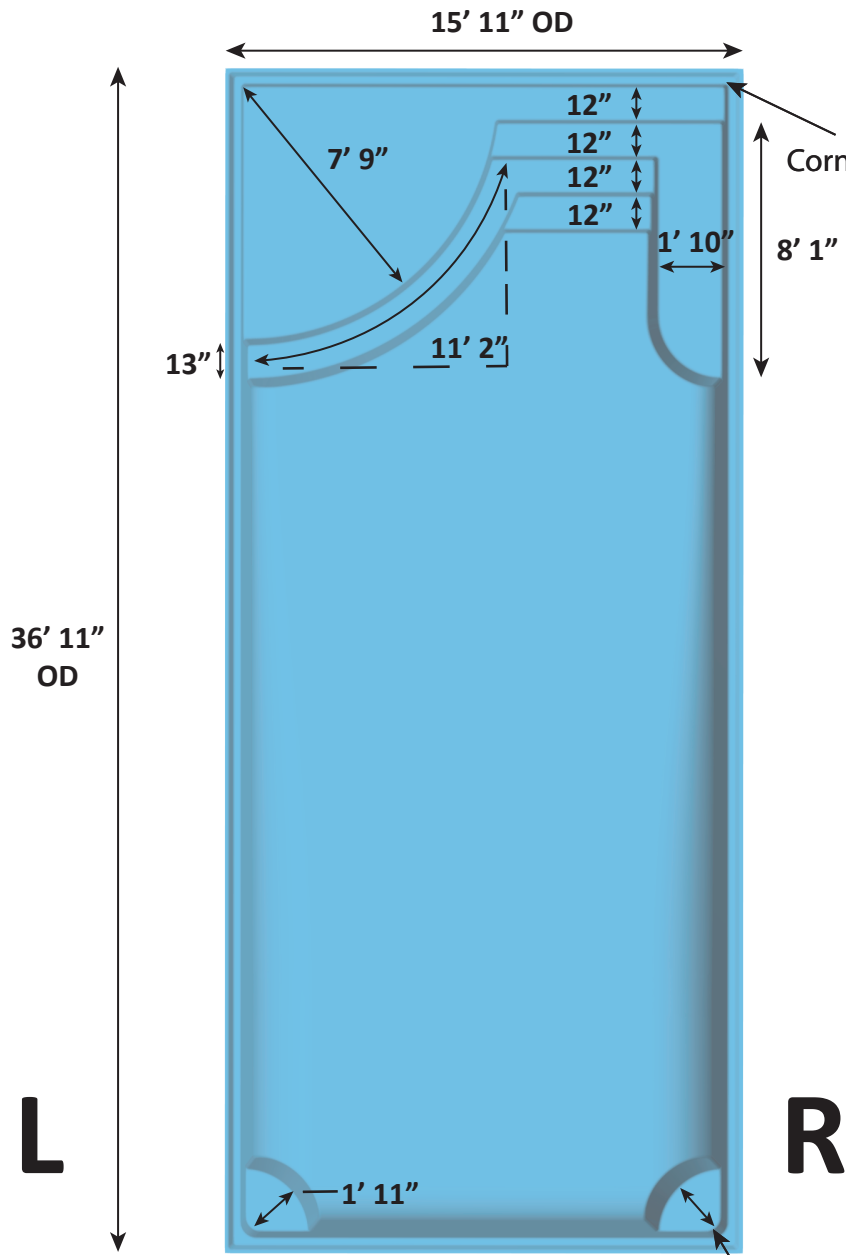

Surface Area: 543 Sq. ft.
 Perimeter: 102.16 Lin. ft.
 Volume: 18,653 Gal.
 Per sect. 8.1, surfaces that provide footing have slip resistant surfaces.
 All measurements are averages.

Corner Radius = 6"



GREAT LAKES DETAIL SHEET - 10-28-21 - REVISION 02

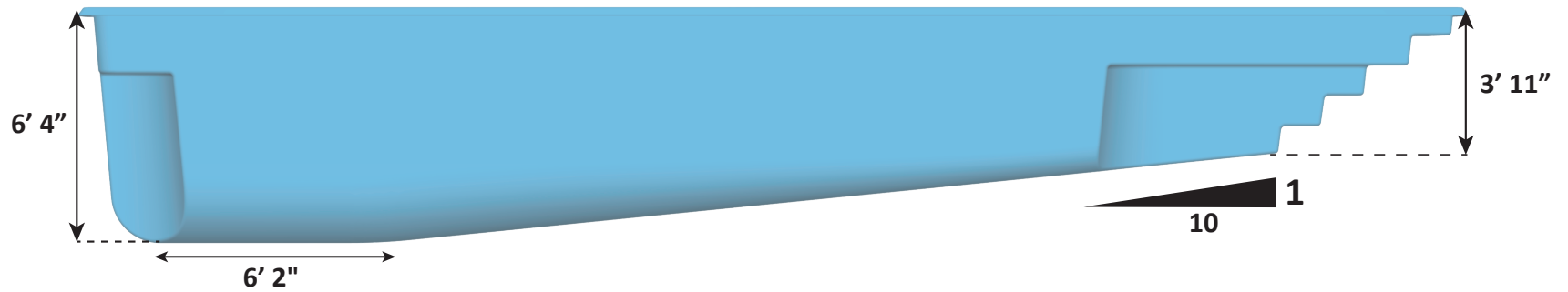
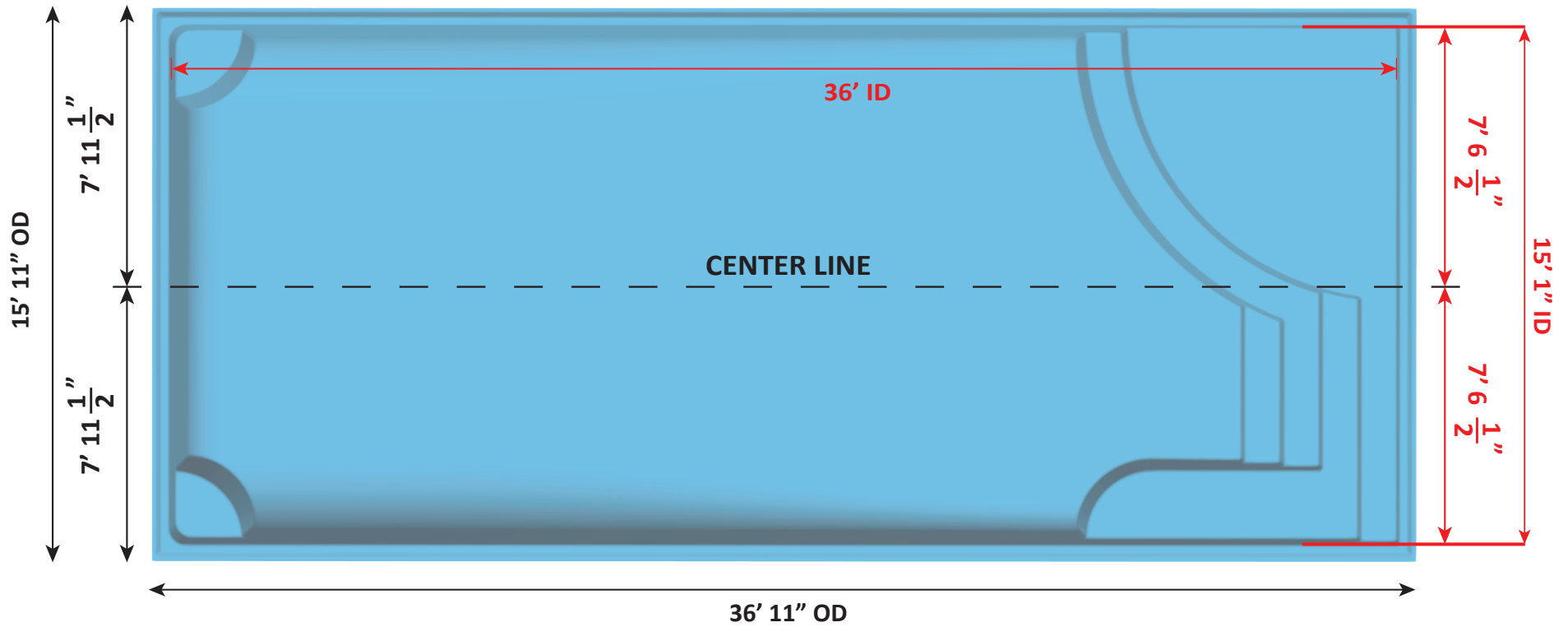

USA Specifications



Surface Area: 543 Sq. ft.
 Perimeter: 102.16 Lin. ft.
 Volume: 18,653 Gal.
 Per sect. 8.1, surfaces that provide
 footing have slip resistant surfaces.
 All measurments are averages.

